



Circular Saw Instruction Manual

Important: Read and understand all instructions before using this tool.

Warranty

Conditions of 1+2 Warranty

You are entitled to a free extended warranty (1 year + 2 years = 3 years) for your Festool power tool. Festool shall be responsible for all shipping costs during the first year of the warranty. During the second and third year of the warranty

the customer is responsible for shipping the tool to Festool. Festool will pay for return shipping to the customer using UPS Ground Service. All warranty service is valid 3 years from the date of purchase on your receipt or invoice.

Festool Limited Warranty

This warranty is valid on the pre-condition that the tool is used and operated in compliance with the Festool operating instructions. Festool warrants, only to the original consumer purchaser, that the specified tool will be free from defects in materials and workmanship for a term of one year from the date of procurement. Festool makes no other warranty, express or implied, for Festool portable power tools. No agent, representative, distributor, dealer or employee of Festool has the authority to increase or otherwise change the obligations or limitations of this warranty. The obligations of Festool in its sole discretion under this warranty shall be limited to the repair or replacement of any Festool portable power tool that is found to be defective as packaged with the User Manual.

Excluded from coverage under this warranty are: normal wear and tear; damages caused by misuse, abuse or neglect; damage caused by anything other than defects in material and workmanship. This warranty does not apply to accessory items such as circular saw blades, drill bits, router bits, jigsaw blades, sanding belts, and grinding wheels. Also excluded are "wearing parts", such as carbon brushes, lamellas of air tools, rubber collars and seals, sanding discs and pads, and batteries.

Festool portable power tools requiring replacement or repair are to be returned with the receipt of purchase to Festool (call 800-554-8741 for address details).

IN NO EVENT SHALL FESTOOL BE LIABLE FOR ANY CONSEQUENTIAL OR INCIDENTAL DAMAGES FOR BREACH OF THIS OR ANY OTHER WARRANTY, EXPRESSED OR IMPLIED WHATSOEVER. ALL WARRANTIES IMPLIED BY STATE LAW, INCLUDING THE IMPLIED WARRANTIES OF MERCHANTABILITY AND FITNESS FOR A PARTICULAR PURPOSE, ARE HEREBY LIMITED TO THE DURATION OF THREE YEARS.

Some states in the U.S. and some Canadian provinces do not allow the limitations on how long an implied warranty lasts, so the above limitation may not apply to you. With the exception of any warranties implied by state or province law as hereby limited, the foregoing express limited warranty is exclusive and in lieu of all other warranties, guarantees, agreements and similar obligations of Festool. This warranty gives you specific legal rights and you may also have other rights which vary from state to state in the U.S., and province to province in Canada.

As hereby limited, the foregoing express limited warranty is exclusive and in lieu of all other warranties, guarantees, agreements and similar obligations of Festool. This warranty gives you specific legal rights and you may also have other rights which vary from state to state in the U.S. and province to province in Canada.

Liability Statement

This product has been built to the high standards of Festool. Please do not attempt to operate or repair this equipment without adequate training. Any use, operation, or repair in contravention of this document is at your own risk. By acceptance of this system you hereby assume all liability

consequent to your use or misuse of this equipment. Festool assumes no liability for incidental, special, or consequential damage of any kind. Equipment specifications, applications, and options are subject to change at the sole discretion of Festool without notice.

Proprietary Notice

All drawings and information herein are the property of Festool, TTS Tooltechnic Systems AG & Co. KG. All unauthorized use and reproduction is prohibited.

Written and Illustrated by Rick Christopherson.

© 2005 TTS Tooltechnic Systems AG & Co. KG

All rights reserved. Printed in the United States of America and Germany.

Festool is a trademark and service mark of TTS Tooltechnic Systems AG & Co. KG

www.festoolusa.com

Contents

Warranty	2	Setting the Blade Depth.....	13
Conditions of 1+2 Warranty	2	Setting the Motor Speed	13
Festool Limited Warranty	2	Turning On the Saw	14
Liability Statement	2	Using the Outrigger Splinter Guard	14
Proprietary Notice.....	2	Setting the Bevel Angle	15
General Safety Rules.....	4	Using the Guide Stop.....	15
Work Area Safety	4	Using Dust Extraction.....	16
Electrical Safety	4	Applications	17
Extension Cords	4	Straight-Lining Rough Lumber	17
Personal Safety	4	Crosscutting and Trimming.....	18
Tool Use and Care.....	4	Plunge Cutting.....	19
Service.....	5	Cutting Non-Wood Materials.....	20
Specific Safety Rules for Circular Saws.....	5	Soft Plastics	20
Causes and Prevention of Kickback	5	Brittle Plastics	20
Respiratory Exposure Warning.....	5	Thin Aluminum.....	20
Extruded Aluminum	20	Accessories.....	21
Tool Description.....	6	Sawblades.....	21
Technical Specifications.....	6	Guide Rails	22
Single-Point Entry	7	Dust Cover	22
Setup and Adjustments.....	7	Guide Rail Accessory Kit.....	22
Setting up a New Saw	7	Rip Fence (Parallel Guide)	22
Adjusting the Guide Rail Gib Cams	8	Systainer (System Container)	23
Trimming the Guide Rail Splinter Guard	8	Troubleshooting.....	24
Trimming the Outrigger Splinter Guard	9	Maintenance	25
Replacing and Adjusting the Riving Knife	9	Routine Maintenance	25
Changing the Sawblade.....	10	Replacing the Guide Rail Gib Cams	26
Setting the Blade Perpendicular to the Sole Plate....	11	Replacing the Guide Rail Splinter Guard	26
Adjusting the 45° Bevel Stop.....	12	Changing the Motor Brushes.....	27
Matching the TS 55 to an Existing Guide Rail.....	12		
Operation	13		

General Safety Rules

WARNING: Read and understand all instructions listed below. Failure to heed instructions may result in personal injury, electrocution, or fire hazard.

Save These Instructions

Work Area Safety

- ▶ **Keep your work area clean and well lit.** Cluttered benches and dark areas invite accidents.
- ▶ **Do not operate power tools in explosive atmospheres, such as in the presence of flammable liquids, gases, or dust.** Power tools create sparks which may ignite the dust or fumes.
- ▶ **Keep bystanders, children, and visitors away while operating a power tool.** Distractions can cause you to lose control.

Electrical Safety

- ▶ **Double insulated tools are equipped with a polarized plug (one blade is wider than the other).** This plug will fit in a polarized outlet only one way. If the plug does not fit fully into the outlet, reverse the plug. If it still does not fit, contact a qualified electrician to install a polarized outlet. Do not change the plug in any way. Double insulation eliminates the need for the three wire grounded power cord.
- ▶ **Avoid body contact with grounded surfaces such as pipes, radiators, ranges and refrigerators.** There is an increased risk of electric shock if your body is grounded.
- ▶ **Do not expose power tools to rain or wet conditions.** Water entering a power tool will increase the risk of electric shock.
- ▶ **Do not abuse the cord.** Never use the cord to carry the tools or pull the plug from an outlet. Keep cord away from heat, oil, sharp edges or moving parts. Replace damaged cords immediately. Damaged cords increase the risk of electric shock.

Extension Cords

All due care should be practiced while using extension cords with this tool.

- ▶ **When operating a power tool outside, use an outdoor extension cord marked "W-A" or "W".** These cords are rated for outdoor use and reduce the risk of electric shock.
- ▶ **Never use an extension cord that is damaged, such as cuts, exposed wires, or bent/missing prongs.**
- ▶ **Use only extension cords rated for the purpose.**
- ▶ **Use only extension cords rated for the amperage of this tool and the length of the cord.** Using too small of an extension cord can cause the router to lose power and damage the tool.

Extension Cord Ratings	
Cord Length	Size (AWG)
<50 Ft.	14
50-100 Ft.	12
100-150 Ft.	10
>150 Ft.	Not recommended

Personal Safety

- ▶ **Stay alert, watch what you are doing, and use common sense when operating a power tool. Do not use tool while tired or under the influence of drugs, alcohol, or medication.** A moment of inattention while operating power tools may result in serious personal injury.
- ▶ **Dress properly. Do not wear loose clothing or jewelry. Contain long hair. Keep your hair, clothing, and gloves away from moving parts.** Loose clothes, jewelry, or long hair can be caught in moving parts.
- ▶ **Avoid accidental starting. Be sure the switch is off before plugging in the power cord.** Carrying tools with your finger on the switch or plugging in tools that have the switch on invites accidents.
- ▶ **Remove adjusting keys or wrenches before turning the tool on.** A wrench or a key that is left attached to a rotating part of the tool may result in personal injury.
- ▶ **Do not overreach. Keep proper footing and balance at all times.** Proper footing and balance enables better control of the tool in unexpected situations.
- ▶ **Use safety equipment. Always wear eye protection.** Dust mask, non-skid safety shoes, hard hat, or hearing protection must be used for appropriate conditions. (Ordinary glasses are NOT proper eye protection.)

Tool Use and Care

- ▶ **Use clamps or other practical way to secure and support the workpiece to a stable platform.** Holding the work by hand or against your body is unstable and may lead to loss of control.
- ▶ **Do not force the tool. Use the correct tool for your application.** The correct tool will do the job better and safer at the rate for which it is designed.
- ▶ **Do not use the tool if the switch does not turn it on or off.** Any tool that cannot be controlled with the switch is dangerous and must be repaired.
- ▶ **Disconnect the plug from the power source before making any adjustments, changing accessories, or storing the tool.** Such preventive safety measures reduce the risk of starting the tool accidentally.
- ▶ **Store idle tools out of reach of children and other untrained persons.** Tools are dangerous in the hands of untrained users.
- ▶ **Maintain tools with care. Keep cutting tools sharp and clean.** Properly maintained tools with sharp cutting edges are less likely to bind and are easier to control.
- ▶ **Check for misalignment or binding of moving parts, breakage of parts, and any other condition that may affect the tool's operation. If damaged, have the tool serviced before using.** Many accidents are caused by poorly maintained tools.
- ▶ **Use only accessories that are recommended by the manufacturer for your model.** Accessories that may be suitable for one tool may become hazardous when used on another tool.

Service

- ▶ **Tool service must be performed only by qualified repair personnel.** Service or maintenance performed by unqualified personnel could result in a risk of injury.
- ▶ **When servicing a tool, use only identical replacement parts.** Use of unauthorized parts or failure to follow maintenance instructions may create a risk of electric shock or injury.

Specific Safety Rules for Circular Saws

⚠WARNING: Risk of personal injury.

- ▶ **Keep hands away from the blade and cutting area.** Keep your second hand on the auxiliary handle. If both hands are holding the saw, they cannot be cut by the blade.
- ▶ **Keep your body positioned to either side of the saw blade, but not in line with the saw blade.** Kickback could cause the saw to jump backward. (See “Causes and Prevention of Kickback” below.)
- ▶ **Do not reach underneath the workpiece.** The blade is fully exposed under the workpiece.
- ▶ **Never use a dust extraction system when making cuts that can result in sparks, such as cutting through nails and other ferrous materials.** Sparks and hot embers can cause a fire or explosion in the dust extraction system.
- ▶ **Never hold the piece being cut in your hands or across your leg.** It is important to support the work properly to minimize body exposure, blade binding, or loss of control.
- ▶ **Hold the saw by the insulated handles when performing an operation in which the sawblade may contact hidden wiring or its own cord.** Contact with a “live” wire will make the exposed metal parts of the tool “live” and shock the operator.
- ▶ **When ripping, always use a rip fence or straight edge guide.** This improves the accuracy of cut and reduces the chance for blade binding.
- ▶ **Always use blades with the correct size and shape arbor holes.** Blades that do not match the mounting hardware of the saw will run eccentrically, causing loss of control.
- ▶ **Never use damaged or incorrect blade flanges or bolt.** The blade flanges and bolt were specially designed for your saw for optimum performance and safety of operation.

Causes and Prevention of Kickback

Kickback is a sudden reaction to a pinched, bound, or misaligned saw blade that causes an uncontrolled saw to lift up and out of the workpiece toward the operator.

When the blade is pinched or bound tightly by the kerf closing down, the blade stalls and the motor reaction drives the unit rapidly back toward the operator.

If the blade becomes twisted or misaligned in the cut, the teeth at the back edge of the blade can dig into the top surface of the wood, causing the blade to climb out of the kerf and jump back toward the operator.

Kickback is the result of incorrect operating procedures or conditions and can be avoided by taking proper precautions as described below:

- ▶ **Maintain a firm grip with both hands on the saw and position your body and arm to allow you to resist kickback forces.** Kickback forces can be controlled by the operator if proper precautions are taken.
- ▶ **If the blade is binding or when interrupting a cut for any reason, release the trigger and hold the saw motionless in the material until the blade comes to a complete stop.** Never attempt to remove the saw from the work or pull the saw backward while the blade is in motion, or kickback may occur. Investigate and take corrective actions to eliminate the cause of blade binding.
- ▶ **When restarting a saw in the workpiece, center the saw blade in the kerf and check that the saw teeth are not engaging the material.** If the saw blade is binding during a restart, it may climb up or kickback from the workpiece.
- ▶ **Do not use a dull or damaged blade.** Dull or improperly sharpened blades cause excessive friction, blade binding, and kickback.
- ▶ **Support large panels to minimize the risk of the blade pinching and causing a kickback.** Large panels tend to sag under their own weight.

Supports must be placed under the panel on both sides, near the line of cut and near the edge of the panel as shown.

- ▶ **The bevel adjusting knobs must be fully tightened before making a cut.** If the blade tilts during a cut, it will bind and cause a kickback.
- ▶ **Use extra caution when making a plunge cut into existing walls or other blind areas.** The protruding blade may cut objects that can cause kickback.

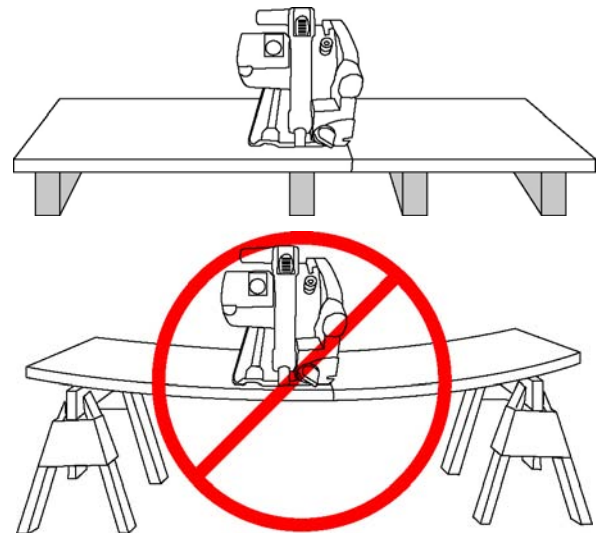

Respiratory Exposure Warning

Various dust created by power sanding, sawing, grinding, drilling and other construction activities contains chemicals known (to the State of California) to cause cancer, birth defects or other reproductive harm. Some examples of these chemicals are:

- ▶ lead from lead-based paints,
- ▶ crystalline silica from bricks, cement, and other masonry products,
- ▶ arsenic and chromium from chemically-treated lumber.

The risk from these exposures varies, depending on how often you do this type of work. To reduce your exposure to these chemicals: work in a well ventilated area, and work with approved safety equipment, such as dust masks that are specially designed to filter out microscopic particles.

Tool Description

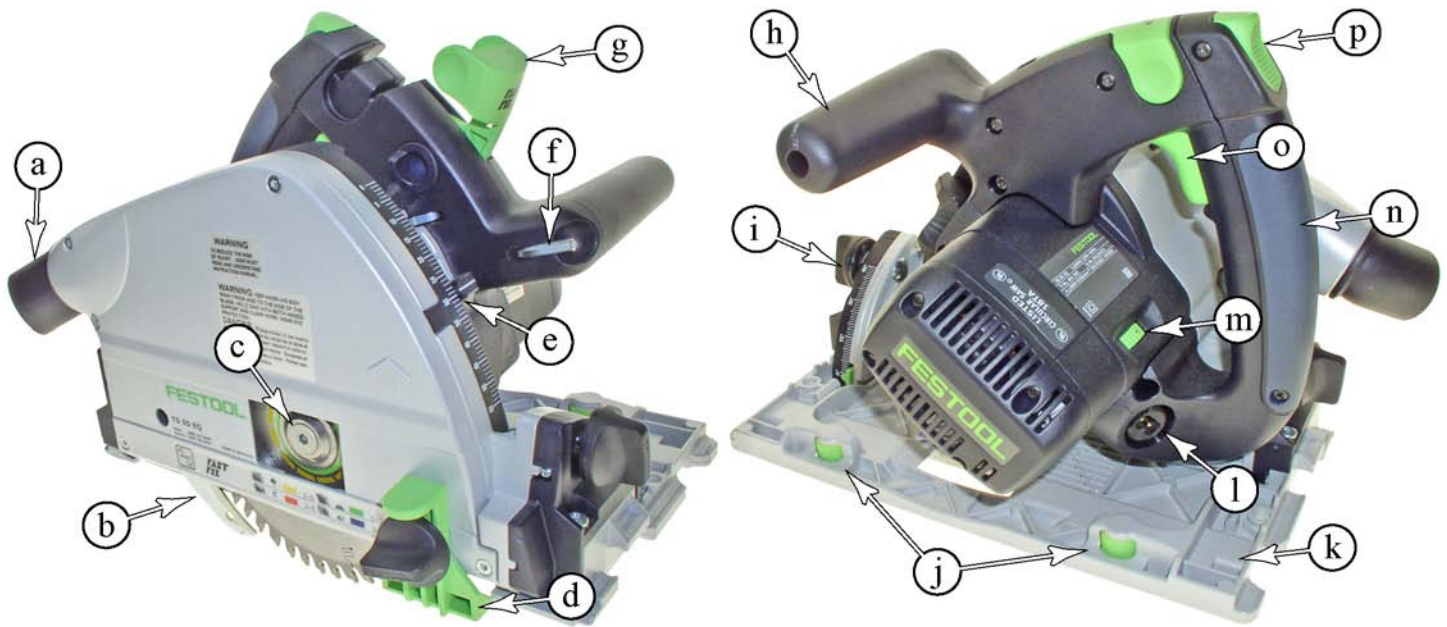

Figures 1a and 1b

- a. Dust Collection Port.
- b. Spring Loaded Riving Knife.
- c. Arbor Bolt.
- d. Outrigger Splinter Guard.
- e. Depth Stop and Gauge.
- f. Blade Wrench Storage.
- g. FastFix Arbor/Plunge Lock.
- h. Auxiliary Handle.
- i. Bevel Gauge and Lock Knob.
- j. Guide Rail Gib Cams.
- k. Sole Plate.
- l. Plug-it Power Cord Port.
- m. Speed Control.
- n. Main Handle.
- o. Trigger (On/Off Switch).
- p. Plunge Release and Trigger Safety Release.

Technical Specifications

Power Consumption	1200 Watts (10 amps @ 120 volts)
Speed Range	2,000 to 5,200 RPM (no load)
Blade Diameter	160 mm
Arbor Diameter	20 mm/Round
Depth of Cut (without guide rail)	55 mm (2.2") @ 90°/43 mm (1.7") @ 45°
Bevel Angle	0° to 45°
Weight	4.5 kg (9.9 lbs)
Certifications	UL745, CSA C22.2/745

All metric dimensions are binding. Sawblade dimensions are critical for safe operation, and are presented in metric units only.

The TS 55 has several features to protect the motor from misuse.

- ▶ The TS 55 has thermal overload protection. If the motor overheats from extended heavy use, the electronic controller will shut down the motor until it cools down. This is to protect the motor from permanent damage. Once the thermal overload has activated, simply wait a

few minutes for the motor to cool down before resuming operation. The thermal overload resets automatically when the temperature returns to normal.

- ▶ The TS 55 also has over-current protection. If the electrical current to the motor exceeds the safe limit (such as what happens with a pinched blade), the motor is temporarily disabled to protect itself. The motor is automatically reset when the power trigger is released.

Single-Point Entry

Single point entry means that the sawblade always enters the cut at the same location regardless what the bevel angle is set to. The pivot point of the bevel adjustment is located at the bottom edge of the splinter guard. This means that the cut will always be along the splinter guard for any bevel setting.

(Note that this is applicable only when the guide rail is used. When the guide rail is not under the saw, the bevel cut will move slightly outward, away from the main body of the saw.)

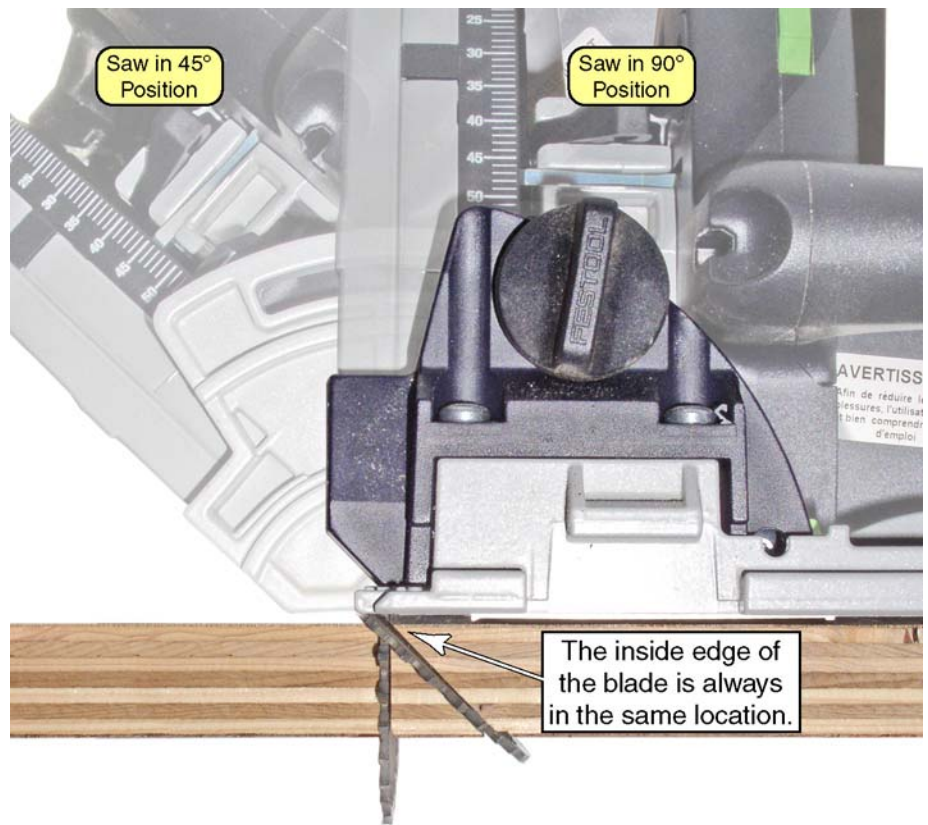

Setup and Adjustments

Setting up a New Saw

There are some simple setup procedures to follow before a new saw can be used. Follow this sequence of inspections and adjustments before using the saw for the first time. It is important that these instructions be followed sequentially before cutting the zero-clearance splinter guards.

⚠WARNING: Always disconnect the saw from the power supply before making any adjustments to the saw or installing or removing any accessory!

1. With the saw unplugged, inspect the blade for damage and make sure it is properly secured to the arbor. (Refer to "Changing the Sawblade" on page 10 for more information).

⚠WARNING: Check regularly whether the saw blade is in good condition. Saw blades which are cracked, damaged, or deformed should no longer be used.

2. The riving knife is installed and adjusted at the factory, however, you should verify that it is properly secured and adjusted (refer to page 9 for more information).

⚠CAUTION: The riving knife is a safety feature of the saw to prevent binding in the cut. All saw work should be carried out only with the riving knife installed and correctly set!

3. Install the power cord into the [Plug It] receptacle on the saw (refer to page 14 for more information).
4. Perform the guide rail gib cam adjustment procedure described on page 8.
5. After completing all of the inspections and adjustments listed above, cut the zero-clearance splinter guards as described on page 8.

Adjusting the Guide Rail Gib Cams

The guide rail gib cams tighten against the rib of the guide rail to remove any side-play from the saw during a cut. Thumbwheels on the top of the cams permit easy adjustment.

1. Place the saw on the guide rail.
2. Loosen both cams by rotating the thumbwheels counterclockwise.
3. Working with one cam at a time, jiggle the saw side-to-side while turning the cam clockwise until the saw fits snugly to the rail.
4. Repeat for the second cam.
5. Make sure the cams are not over tightened by sliding the saw down the guide rail. If the saw does not slide easily, loosen the cams.

Notes:

- ▶ The cams do not need to be very tight for normal operations. A tiny amount of side-play will not impact the quality of a cut.

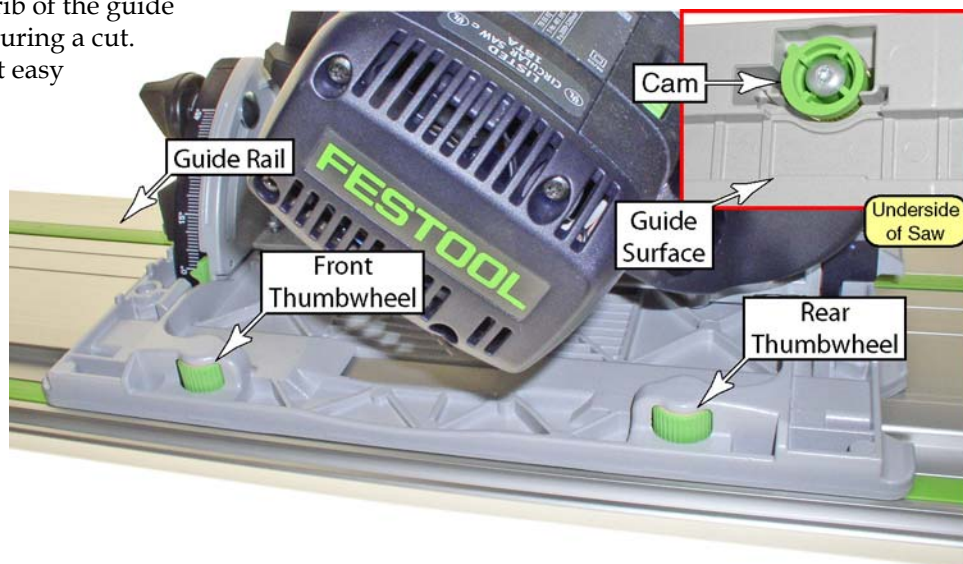

- ▶ The cam action of the gibs allows for a large force to be applied to the gibs from a small amount of turning of the thumbwheel.
- ▶ Over tightening the cams or operating the saw in abrasive environments can cause premature wear. Periodically inspect the cams for flat spots, and replace if necessary.

Trimming the Guide Rail Splinter Guard

The leading edge of the guide rail has a replaceable, rubber, zero-clearance strip. The first time the saw is used with the guide rail, this strip is trimmed to match the sawblade. When trimmed to size, this strip reduces chipping and tearout during normal cutting.

i If you have more than one saw that uses the same guide rail system, you want all of the tools to have the same cutting path. Before cutting the splinter guard, use the "Matching the TS 55 to an Existing Guide Rail" procedure described on page 12 to match one tool to another.

1. Set the blade depth very shallow (6 to 7 mm) so that the blade teeth penetrate the strip by about half a tooth, as shown.
2. Set the motor speed to its lowest setting (setting 1).

3. Place the guide rail on a stable surface with the strip hanging over the edge so you don't cut the table.
4. If necessary, adjust the guide rail gib cams as described on page 8.
5. Cut the strip in a single, smooth, low-speed rip from one end of the guide rail to the other.

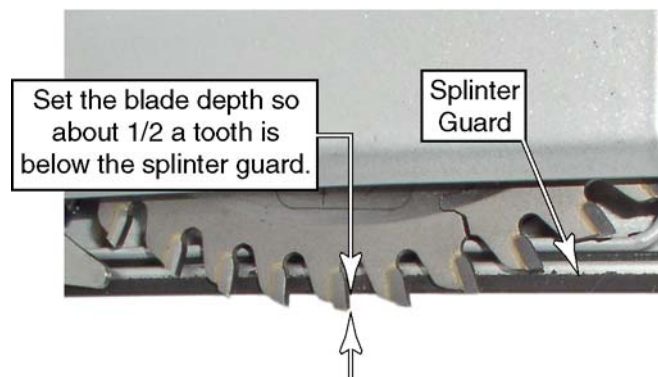

Trimming the Outrigger Splinter Guard

The outrigger splinter guard is used to prevent chipping on the offcut side of the sawblade. The outrigger can be retracted away from the workpiece when not needed.

Before the outrigger splinter guard is used for the first time, it needs to be trimmed to fit the sawblade.

1. Remove the thumbscrew from the outrigger and slide the outrigger on to the front edge of the blade guard as shown.
2. Insert the thumbscrew through the outrigger, through the height adjustment slot, and into the captive nut on the back side of the outrigger.
3. Raise the outrigger to its top position and tighten the thumbscrew.
4. Place the saw on a stable surface so that the blade can be plunged down without cutting the surface (or use a piece of scrap wood).
5. Set the motor speed to its lowest setting (setting 1).
6. Start the saw and slowly plunge the blade to full depth.

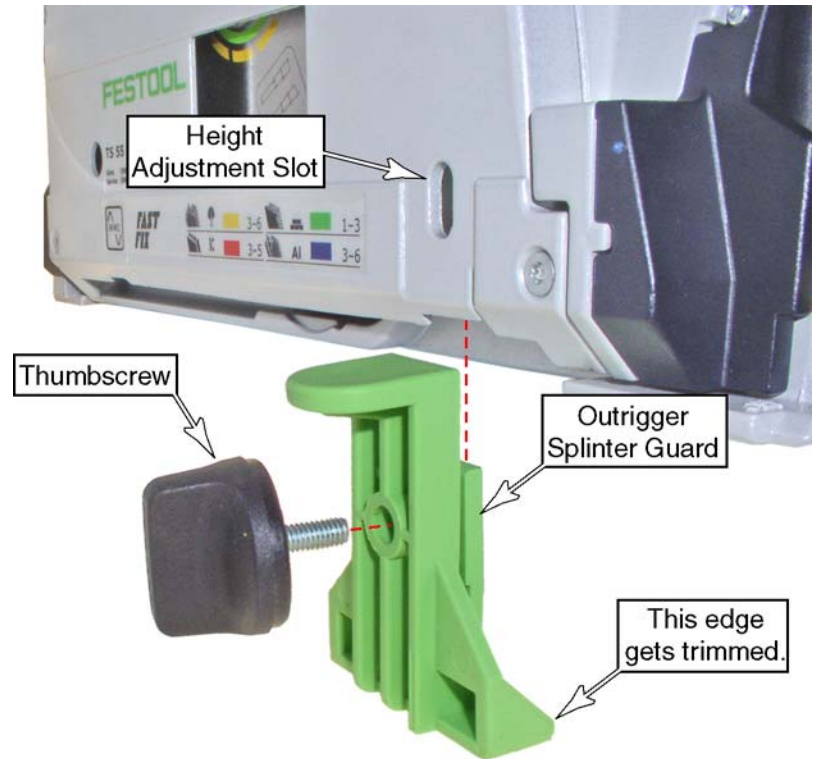

Replacing and Adjusting the Riving Knife

Periodically inspect the riving knife to ensure it is not bent and has proper clearance away from the blade. Replace if bent.

1. Unplug the saw for safety.
2. Raise the FastFix latch lever and plunge the saw until it locks into position (see page 10 for more information on the FastFix lever).
3. Using the arbor wrench (stored in the auxiliary handle) loosen the riving knife mounting screw.
4. If the riving knife needs replacement, slide it out of its mounting, and slide a new knife back in.
5. Raise or lower the riving knife so there is a 2 to 4 mm ($3/32$ to $5/32$ inch) clearance between the knife and the blade.
6. Retighten the mounting screw.



Changing the Sawblade

The TS 55 saw features the FastFix system for easier blade changing. The FastFix system is engaged by raising the FastFix latch lever and plunging the saw down. The system includes the following features:

- ▶ For safety, the power switch is locked out.
- ▶ The plunge depth is locked in the position shown to the right with the arbor bolt accessible through an opening in the blade cover.
- ▶ The arbor is locked from turning.
- ▶ The riving knife mounting screw is accessible through an opening in the blade cover.

Sawblade Checks and Warnings

- ▶ Use only sawblades that are approved for use with the saw and appropriate for the type of material being cut.
- ▶ Use only sawblades with a diameter of 160 mm, and an arbor bore of 20 mm.
- ▶ Do not use a sawblade that is bent or warped.
- ▶ Do not use a sawblade with missing or damaged teeth.

Removing the Sawblade

1. Unplug the saw for safety.
2. Although not required, you may wish to remove the outrigger splinter guard for better clearance.
3. Raise the FastFix latch lever.
4. Press upward on the plunge lock release button and plunge the saw down until it locks into position.
5. Using the arbor wrench (stored in the auxiliary handle) loosen the arbor bolt by turning it counterclockwise.
6. Remove the arbor bolt and washer.
7. Retract the riving knife out of the way and remove the blade from the saw.

Replacing the Sawblade

1. While retracting the riving knife, insert the blade into the saw and over the arbor flange. Make sure the blade's teeth are facing forward in the direction shown above.
2. Place the arbor washer over the arbor flange and rotate it until the alignment keys engage with the arbor flange.
3. Replace the arbor bolt and tighten it firmly.
4. While pressing down on the auxiliary handle, lower the FastFix latch, and slowly release the plunge.

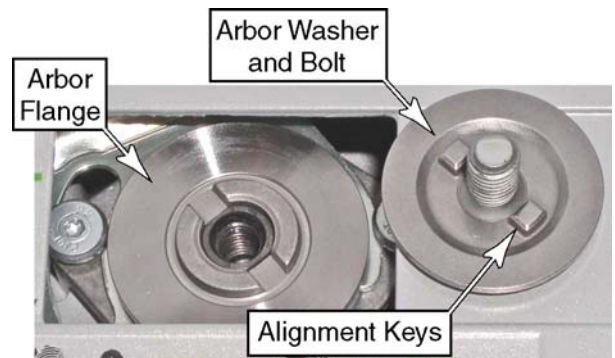
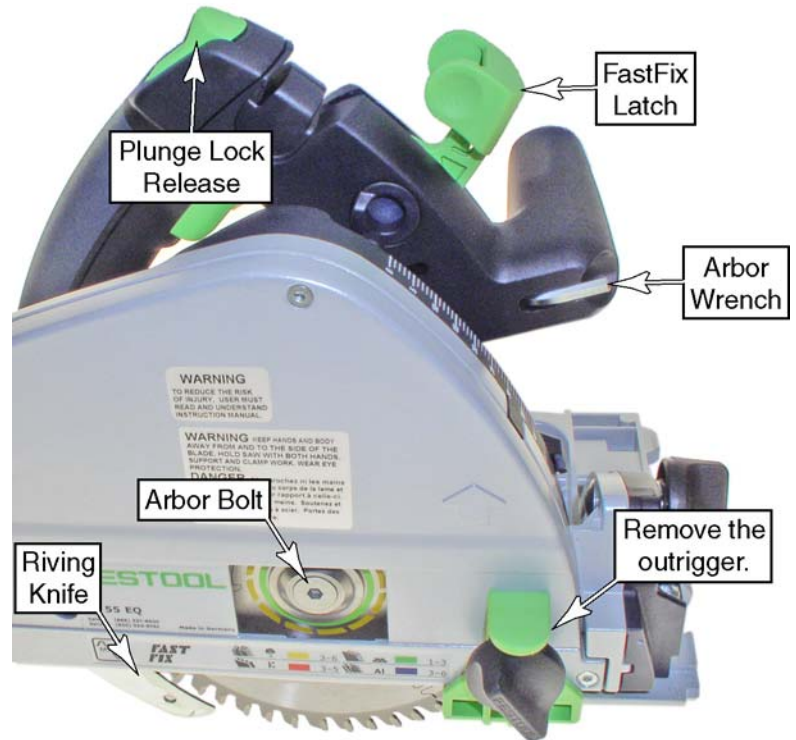

Setting the Blade Perpendicular to the Sole Plate

This adjustment ensures that cuts are made square to the workpiece surface. This adjustment is completed at the factory and shouldn't need to be adjusted unless the tool has been modified or serviced.

The most accurate method for checking the square of the blade is to make a cut with the saw and examine the resulting cut.

For even greater accuracy, the procedure below uses a method that amplifies a small measurement into a larger measurement to make it easier to observe. This doubles the accuracy of the adjustment.

Adjustment Procedure

- Using the guide rail, carefully cut a small piece of wood in half.
 - This is a precision adjustment. Make sure the guide rail and workpiece are securely clamped.
 - The piece should be at least $\frac{3}{4}$ inch thick by 12 inches square.
 - The thicker the piece, the more accurate the adjustment will be.
 - For best results, the material should have a consistent center, such as Medium Density Fiberboard (MDF), plastic, or solid lumber.
- Place the two pieces back together to verify that the original cut-line is tight (Figure A). If the cut-line is not tight, make a new cut.
- Flip the offcut board end-for-end so the cut-line is still together but the board is upside down. (Don't flip the board that was under the saw.)
- Inspect the joint between the two boards:
 - If there is no gap then the adjustment is correct.
 - If the gap is at the top of the two boards (Figure B), then turn the adjustment screws clockwise.
 - If the gap is at the bottom of the two boards (Figure C), then turn the adjustment screws counterclockwise.
- Loosen the front and rear bevel lock knobs (see image to the right).
- Turn the two stop screws in the direction determined in step 4. (Make sure to turn both screws the same amount.) Each turn of the adjustment screw will have the following effect:
 - 1 turn equals 1 degree of adjustment.
 - 1 turn equals $\frac{1}{2}$ mm of gap between the boards shown above (assuming $\frac{3}{4}$ inch thick boards).
- Verify the adjustment setting by repeating steps 1 through 4.

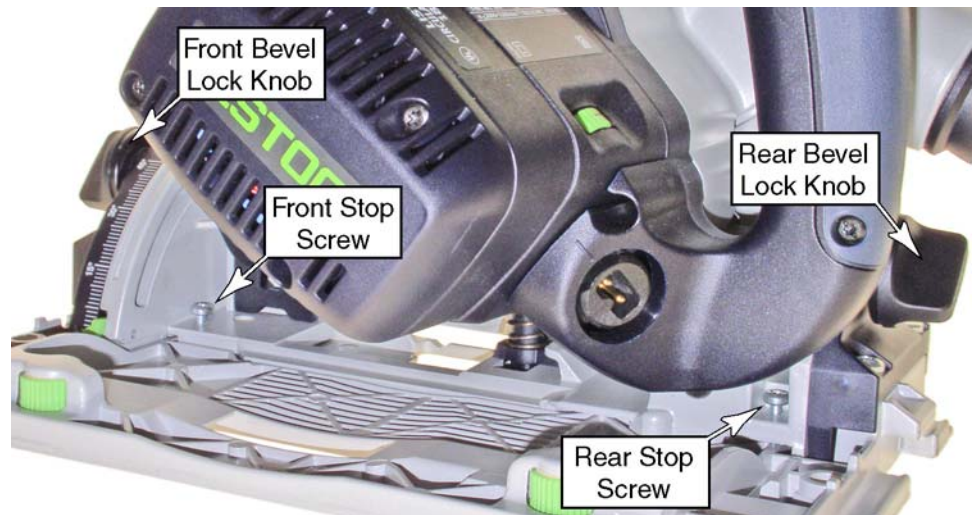
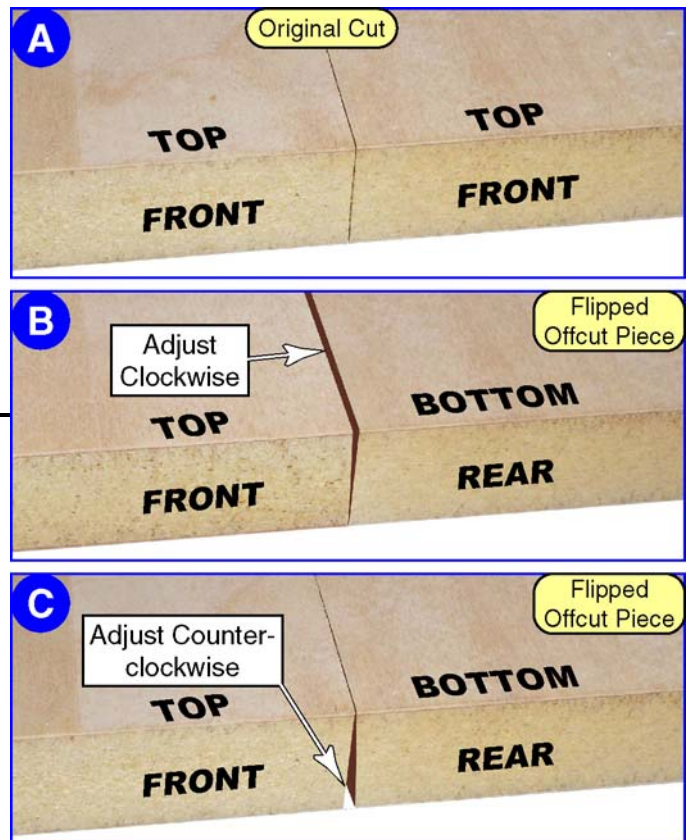

Adjusting the 45° Bevel Stop

The bevel setting has a positive stop at 45° and is adjustable for accuracy. In most cases, the bevel stop should be set for 45°, however, some users may prefer to have the stop set slightly larger than 45° for tighter miter corners.

The most accurate method for measuring a 45° angle is to make a box as shown. Any error in the angle will be compounded with each cut made.

1. Take a piece of scrap wood and bevel both sides (double-sided bevel, as shown to the right).
 - ▶ Make sure the cuts are parallel.
 - ▶ The size of the wood is not critical, but should be at least $\frac{3}{4}$ inch thick and about 5 inches wide by 16 to 20 inches long.
2. Cut the piece of wood into 4 equal parts as shown in the top image to the right.
3. Put the four pieces together to form a box.
4. Examine the gaps in the corners of the box:
 - ▶ Gaps at the outside corners indicate the bevel angle is less than 45°. Loosen the setscrew.
 - ▶ Gaps at the inside corners indicate the bevel angle is greater than 45°. Tighten the setscrew.
5. Verify any adjustments by repeating the procedure.

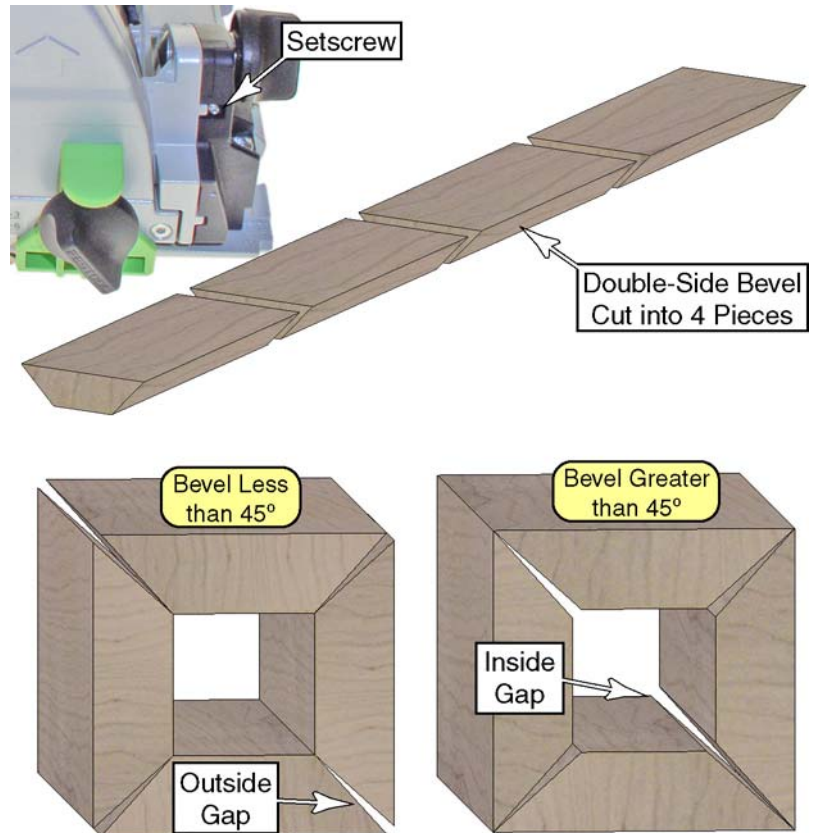

Matching the TS 55 to an Existing Guide Rail

If you have more than one Festool saw, and you want them to share the same guide rails, you can adjust the TS 55 to match the cutting position of a previous saw.

1. Clamp your existing guide rail to a small scrap of wood (about 12 inches long) so it cannot move.
2. Using your existing saw, cut the piece of wood. Do not move the guide rail after the cut is finished.
3. Place the new TS 55 saw on the guide rail.
4. Loosen the four hinge block mounting screws (2-front and 2-rear).
5. Plunge the blade to full depth and hold it there.
6. Slide the front of the sawblade up to the edge of the cut piece of wood.
7. Slide the back of the sawblade up to the edge of the cut piece of wood, except place a piece of paper between the blade and the wood. This paper serves as a shim to space the blade slightly away from the wood at the back of the cut. The saw's cutting is improved if the back of the blade is skewed slightly away from the guide rail.

8. Retighten the hinge block mounting screws.

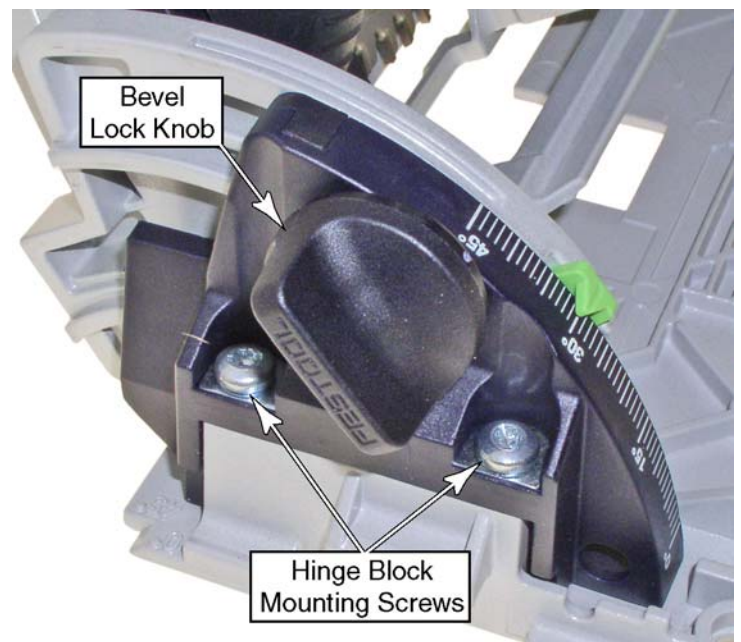

Operation

Setting the Blade Depth

The TS 55 is equipped with a depth stop for setting the depth of the blade during a plunge cut. Using the correct blade depth improves cutting safety, cut quality, and motor efficiency.

Effects of Too Shallow of a Setting

- ▶ Higher drag on the sawblade, requiring more power and effort to complete the cut.
- ▶ Increased chance for kickback.
- ▶ Increased chipping and splintering on the underside of the cut, especially with melamine and veneers.
- ▶ Increased burning of the cut, especially in certain hardwoods like cherry and maple.
- ▶ With the exception of underside chipping, all of these effects are greatest with finer-toothed blades.

Effects of Too Deep of a Setting

- ▶ Increased danger with more of the blade exposed below the workpiece.
- ▶ Increased sawtooth marks in the cut.
- ▶ Increased top-side chipping and splintering, especially without using the guide rail and splinter guards.

Blade Depth Recommendations

There are no set rules for setting the depth of the blade with respect to the underside of the cut. However, a common industry guideline is to have the gullets of the blade even with the underside of the workpiece. This will therefore be used as a baseline to describe optional depth settings.

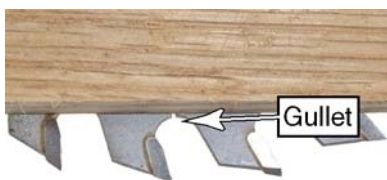

- ▶ If a material is prone to burning in the cut, increase the depth slightly. This includes ripping hardwoods such as cherry and maple.
- ▶ Using a combination blade in solid wood may perform better with a slightly deeper setting.
- ▶ Using a coarse blade in sheet materials may be improved with a shallower cut.
- ▶ Cutting dense and/or hard materials may require a deeper setting to decrease heat and load on the tool.
- ▶ Cutting fragile or shatter-prone materials such as plastics or countertop laminates is best with a shallow setting (and low speed).
- ▶ Cutting aluminum may be improved with a semi-shallow setting, but not too shallow.
- ▶ When Used with the Multi-Function Table (MFT) you may wish to keep the blade depth shallower.
- ▶ Cutting non-fragile, non-shattering plastics such as polypropylene or solid-surface countertops may be improved with a deeper cut.
- ▶ More aggressive blades, such as the Panther ripping blade, can be used at a shallower setting.

Using the Depth Stop

- ▶ Press in on the index pointer and slide it up or down to the desired setting.
- ▶ When used with the guide rail, add 5 mm to the desired depth to account for the guide rail thickness.

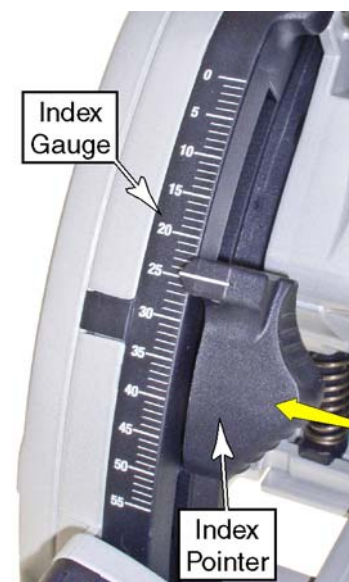

Setting the Motor Speed

The TS 55 has electronic speed control with soft-start circuitry. The electronic controller will maintain the motor speed even as the load changes. The speed control is infinitely variable from 2000 to 5200 RPM. The optimal speed of the saw is predominately determined by the type of material being cut.

Material	Speed
Soft wood products and veneer plywoods	6
Hardwood products	3-6
Plastic laminate countertops	6
Hard plastics	3-5
Soft plastics	1-4
Masonry and cementitious hardboard	1-3
Aluminum	4-6

Turn the speed control dial (shown on page 14) to the number shown in the table to the left.

A Note About Speed Control

When you first turn on the saw and there is no load on the sawblade, you may notice a slight "growling" sound from the saw. This is normal, and is a result of the motor's gears reacting to the speed control.

The electronic controller in the motor controls the motor speed by turning it On and Off very rapidly. This form of speed control is called "Pulse-Width Modulation" (PWM), and is common in most power tools with a variable speed control. When there is no load on the sawblade, the pulsations of the motor cause the gears to rapidly engage and disengage (called backlash), and this is the sound you are hearing.

Turning On the Saw

To prevent unexpected start-ups, the power switch has an integral safety interlock. Before the saw can be started, the plunge release must be engaged.

1. Insert the Plug-it cord into the saw with the keyway lined up with the key, and twist the end to lock it in place.
2. Press up on the plunge release lever.
3. Pull back on the power trigger.

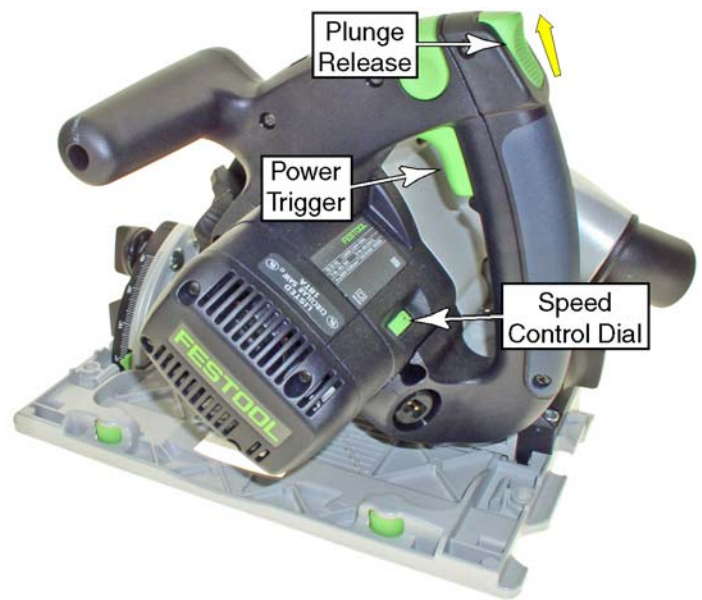
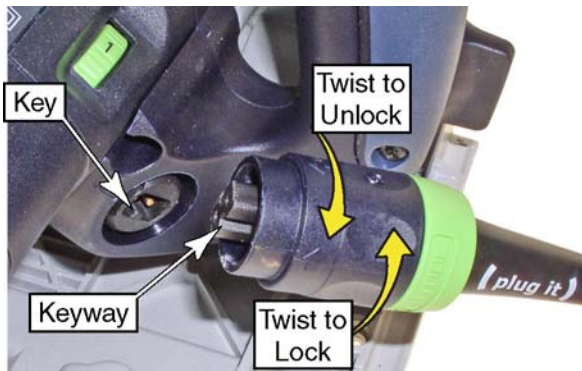

Using the Outrigger Splinter Guard

The outrigger splinter guard is used when the cut to the right of the blade needs to be chip-free. When not in use, the outrigger can be raised out of the way. For bevel cuts, the outrigger is easily removable.

1. Remove the thumbscrew from the outrigger and slide the outrigger on to the front edge of the blade cover as shown.
2. Insert the thumbscrew through the outrigger, through the height adjustment slot, and into the captive nut on the back side of the outrigger.



3. Place the saw on the guide rail, on the workpiece, and lower the splinter guard down to the surface of the workpiece.
4. Tighten the thumbscrew.

Notes

- ▶ Inspect the bottom of the outrigger for burrs that could scratch the workpiece.
- ▶ Remove the outrigger when making bevel cuts.
- ▶ For plunge cuts, there is an index mark to indicate the blade position when the blade is at full depth.

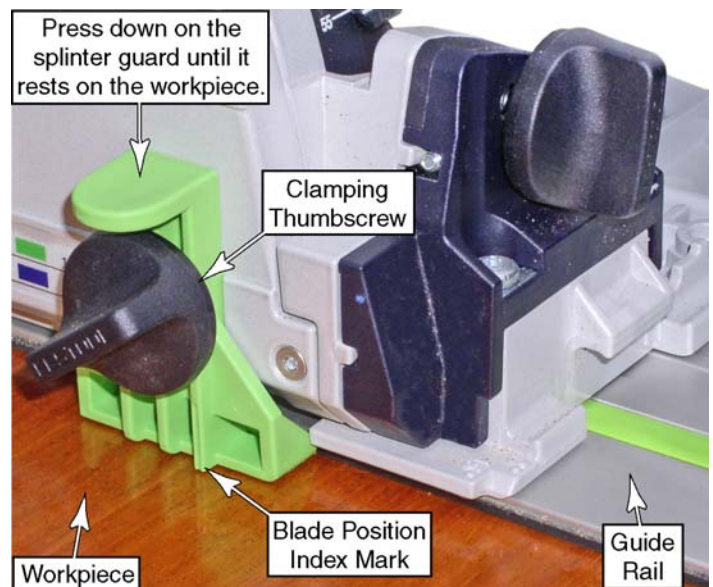

Setting the Bevel Angle

When used with the guide rail, the blade of the TS 55 enters the workpiece at exactly the same location regardless of the bevel angle (see the picture on page 7). However, when used without the guide rail, the cut position moves outward slightly as the bevel angle increases. (The small notch at the front of the sole plate indicates the cut position when the saw is used without the guide rail.)

1. Remove the outrigger splinter guard.
2. Loosen the front and rear lock knobs.
3. Tilt the saw until the index pointer is pointed to the desired bevel angle setting.
4. Tighten the front and rear lock knobs.

i For bevel angles greater than 30 degrees, most of the weight of the saw is beyond the edge of the sole plate. Make sure to hold the sole plate down when cutting to prevent the saw from tipping unexpectedly.

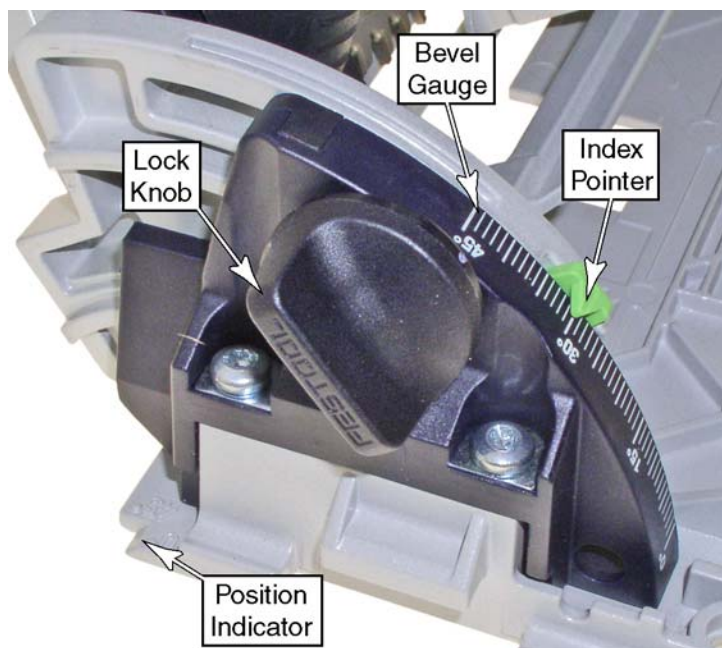

Using the Guide Stop

The guide stop serves two purposes: it controls the saw's position and prevents a kickback during a plunge cut. The leading edge of the guide stop prevents the saw from moving backward as the plunge begins. The anti-kickback lip engages with the sole plate of the saw to prevent the back of the saw from lifting up at the beginning of a plunge cut.

1. Slide the guide stop onto the T-slot of the guide rail with the embossed arrow pointing toward the front of the saw.
2. Position the stop behind the starting position of the saw.
 - ▶ When the blade is at full-depth, the guide stop is 3 3/4 inches behind the start of the cut.
 - ▶ When the blade is less than full depth, the distance between the blade (cut) and the guide stop will be greater.
 - ▶ For best results, you should always verify the blade's cutting position before starting the cut.
3. Tighten the thumbscrew on the guide stop.



Using Dust Extraction

The TS 55 can be used with or without a dust extraction system. The chip diverter swivels to direct the sawdust away from the work area when a dust extraction system is not used.

For best results, however, a dust extraction system (such as the Festool CT 22 shown below) should be used. Festool dust extractors have the added features of variable speed, and sensing when the saw is turned on. The vacuum will automatically start when the saw is turned on, and will remain running for a couple of seconds after the saw turns off to clear the remaining dust.



1. Insert the extractor hose into the chip diverter (36 mm inside diameter [1-7/16 in.])
2. Plug the TS 55 power cord into the auxiliary outlet on the extractor (if so equipped).
3. Set the power switch on the extractor to "Auto." (The auxiliary power outlet is active only when the switch is set to Auto.)

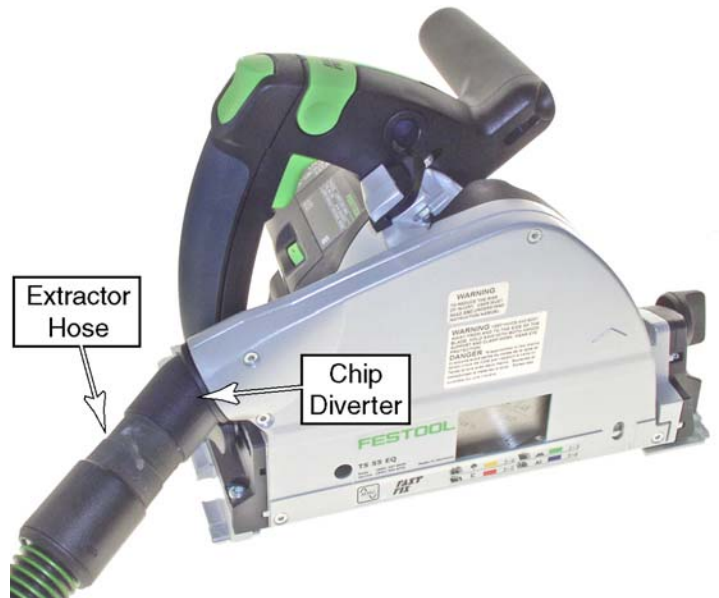

Applications

The TS 55 is capable of performing a wide variety of tasks. The following sections provide information on some of these tasks. This is intended to be an introduction to the capabilities of the saw, but should not be considered as a comprehensive list of its capabilities.

Straight-Lining Rough Lumber

Purchasing lumber directly from a saw mill is significantly less expensive than buying from a home center. However, part of the reason why the lumber is less expensive is because it frequently has not been straight-line ripped.

Sawmills have special straight-line ripping tablesaws, but they charge an extra fee for the service, and straight-lining on a regular tablesaw is complicated.

The TS 55 can quickly and easily straight-line rough lumber using the guide rail. Additionally, if the grain of the wood is diagonal with the cut edge, the TS 55 can be used to re-cut the lumber on a diagonal to match the natural wood grain direction or to avoid defects.

Tips for Successful Straight-Lining

- ▶ Use the correct blade for the cut. The Panther ripping blade will provide the easiest cutting in any hardwood. A coarse combination blade may be used for softwoods, or

for a finer edge, but it will take more effort to rip the wood.

- ▶ The Panther blade is aggressive enough that you do not need to fully expose the whole gullet as shown on page 13. For cleaner cuts, expose $\frac{1}{2}$ to a full tooth of the blade below the wood. The deeper the setting, the easier the cut will be.
- ▶ For a less aggressive, combination blade, you may need to set the depth so the full gullet is exposed below the wood.
- ▶ Choose the orientation of the guide rail to optimize the board usage. This may have several different options:
 - ▶ Align the cut with the natural wood grain orientation.
 - ▶ Align the cut to avoid defects in the wood.
 - ▶ Align the cut to maximize board width, while eliminating curved edges.
- ▶ Place the board on sawhorses or elevate it from a work table so you do not cut into your work table.

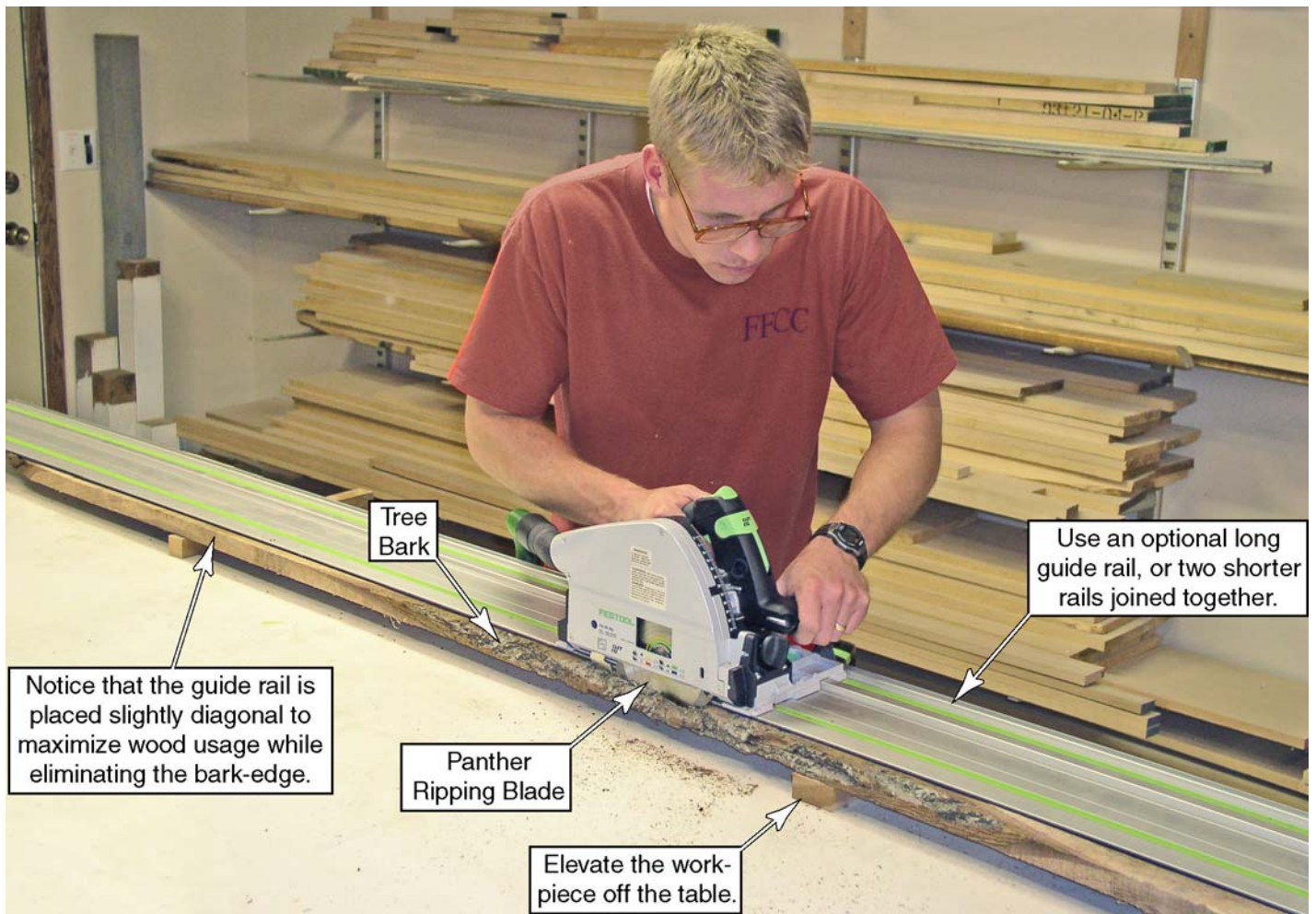

Crosscutting and Trimming

No other saw on the market can outperform a Festool for splinter-free, fine crosscutting. With other saws, the problem is two-fold; getting a straight cut, and achieving a splinter-free cut. The TS 55 handles these problems effortlessly.

Tips for Successful Crosscutting

- ▶ Use the correct blade for the cut.
 - ▶ Crosscutting fine veneered wood should use the fine crosscut blade. The Alternate-Top-Bevel teeth will slice the wood fibers best, with virtually no chipping.
 - ▶ Crosscutting soft lumber, or lumber-core veneers should use the combination blade. With fewer teeth than the fine crosscut blade, this blade will be more aggressive for cutting, yet still provide good chip-free cutting.
 - ▶ Crosscutting thick hardwood lumber, and difficult to cut lumber should use the coarse crosscut blade. The coarse tooth-count of this blade provides very aggressive cutting of difficult material, but won't provide as smooth of a finish as the finer blades.
- ▶ Cutting plastic-veneer countertops or solid surface materials should use the fine laminate blade. The Triple-Chip-Grind of this blade lasts longer in hard materials and reduces chipping in man-made materials. The triple-chip-grind will provide good cuts in wood veneers, but not as good as the alternate-top-bevel fine crosscut blade.
- ▶ For small offcuts, overhang the workpiece from a work table or saw horses (as shown below). For larger offcuts, support both the primary piece and the offcut.
- ▶ If the offcut is reusable, use the outrigger splinter guard to prevent chipping.
- ▶ Make sure the workpiece is secure. The lightweight door shown in the example below would slide on the table if not clamped down.
- ▶ Make sure the guide rail is secure if it can move during the cut. In the example below, starting the cut with the saw behind the workpiece can cause the guide rail to tip up and move. (The guide rail clamps are below the guide rail, and not visible.)
- ▶ Don't start the cut by plunging the saw into the wood, as this can lead to tearout at the bottom-back of the sawblade. Start the cut with the blade down and behind the workpiece, and advance the saw forward into the cut.
- ▶ Setting the blade depth too shallow (just barely penetrating the underside of the workpiece) can cause tearout on the underside of the cut.



Plunge Cutting

Plunge cutting is used when the cut does not start at the edge of the workpiece; it starts in the middle of the workpiece. There is a wide variety of applications for plunge cuts. The example shown below is for insetting a maple butcherblock into an existing countertop. A square cutout is made in the middle of the countertop, and the butcherblock piece is inserted into the cutout.

Notes

- ▶ Always use the guide stop when making a plunge cut to prevent an unexpected kickback (see page 15).
- ▶ Whenever possible, put the guide rail on the side of the cut that will be saved. If the guide rail is placed on the offcut side, you must remember to account for the blade thickness when positioning the guide rail (typically 2.2 mm).
- ▶ Whenever possible, set the saw depth to its maximum setting to minimize the amount of material that is not cut by the blade. Make sure there is nothing below the cut that you don't want to cut into.

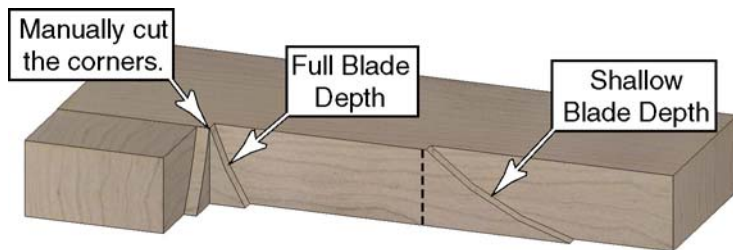

- ▶ Mark the beginning and end of the cut (red tape in picture below). If the blade is at full depth, there are index marks on the saw that indicate where the blade is positioned.



- ▶ For cuts similar to the example below, support the offcut piece before cutting all four sides to prevent it from breaking the corners. Trim the corners (see image to the left) with a handsaw.

General Procedure

1. Place the guide rail on the cutline.
2. Place the saw on the guide rail, and position it at the start of the cut.
3. Install the guide stop on the guide rail, slide it up to the back of the saw, and lock it in place.
4. Start the saw and slowly plunge it down.
5. Advance the saw through the cut until the end is reached. Never back the saw up, as this can result in a kickback.

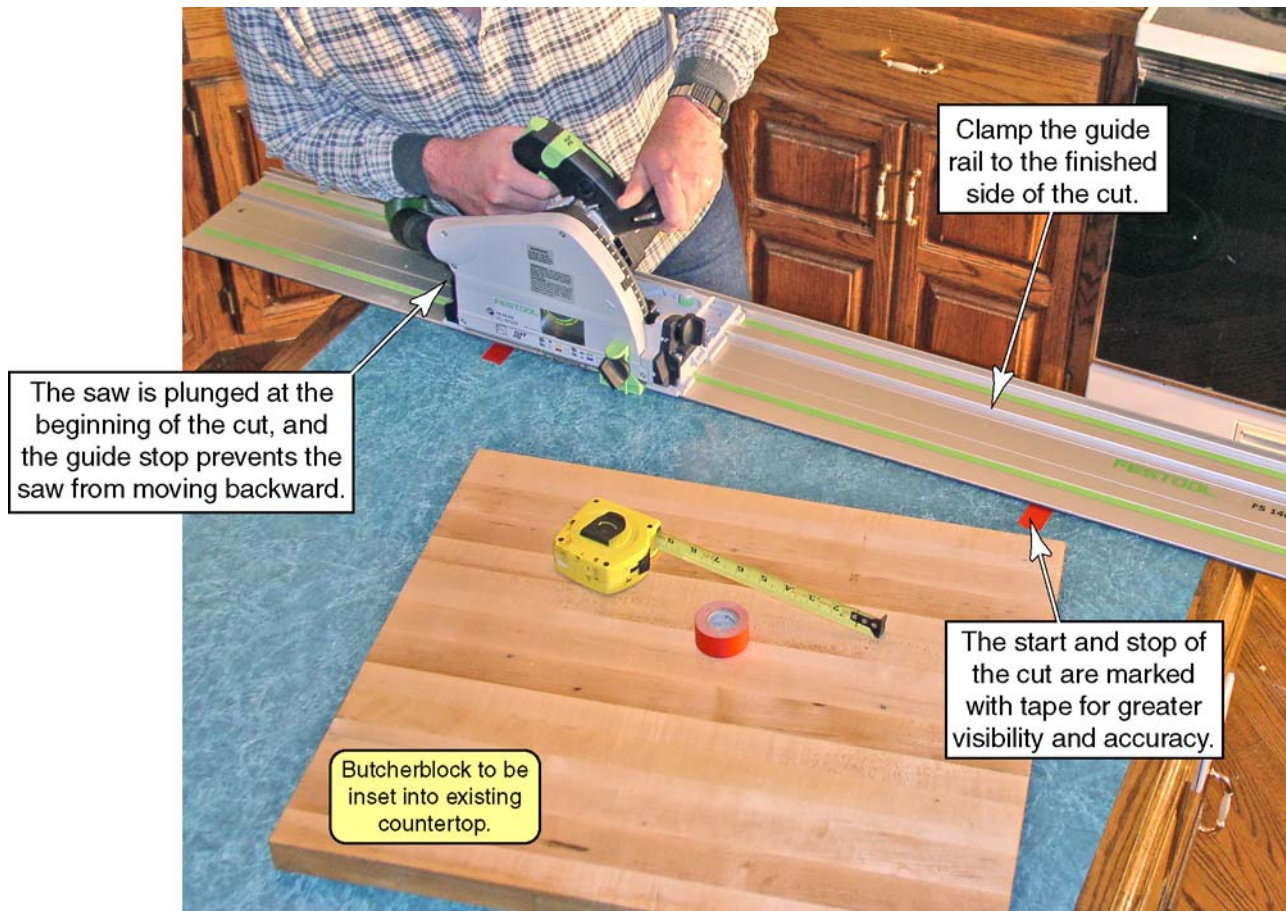

Cutting Non-Wood Materials

Soft Plastics

Soft plastics such as polypropylene won't chip, but they will melt. Therefore, a more aggressive cut with the blade set deeper will reduce the melting.

- ▶ Too shallow of a blade depth and the plastic will be more prone to melting.
- ▶ Too deep of a blade depth and the teeth marks from the blade will be more prevalent.
- ▶ Any of the fine-tooth blades with a slow motor speed will cut this material with good results.
- ▶ Clean up the cut edges with a cabinet scraper.

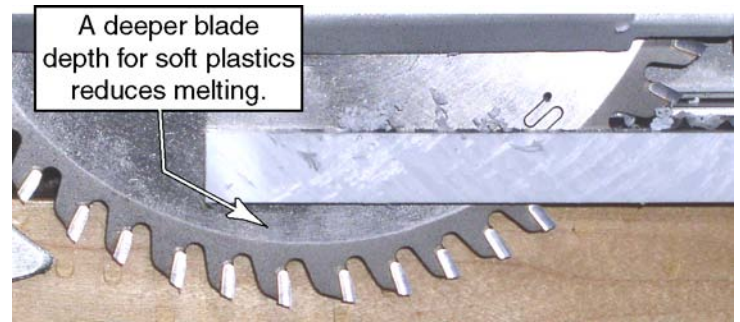

Brittle Plastics

Brittle plastics will both melt and chip, so cutting them is problematic with most other saws. The TS 55 works great for cutting this type of material.

- ▶ Set the blade depth very shallow to reduce chipping.
- ▶ Set the motor speed very low to reduce melting.
- ▶ Use any one of the finer tooth blades for good results, but the negative hook aluminum and plastic blade provides the best results.
- ▶ In clear plastics such as acrylic, if the cut is milky white, it is a sign of melting. Note how the cut to the right is transparent.

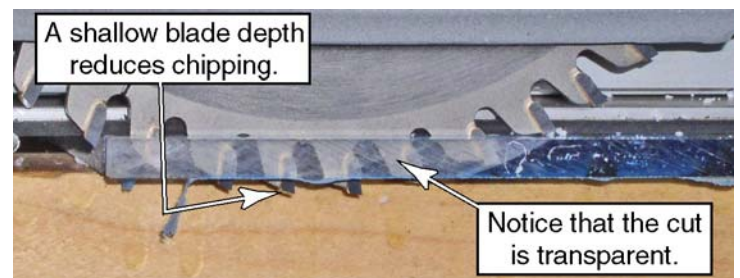

Thin Aluminum

The problem with cutting thin aluminum sheet is that the blade teeth can catch the edge of the sheet, and cut more aggressively than expected. To reduce this, you want the teeth moving nearly parallel with the aluminum surface (a shallow blade depth).

- ▶ The ultra-thin aluminum shown in the example was cut best with the fine crosscut blade. The positive hook angle of the blade kept the flexible aluminum tight to the guide rail in a sheering cut.
- ▶ For slightly thicker, less flexible pieces of aluminum, the negative hook angle, aluminum cutting blade works best because it cuts less aggressively.

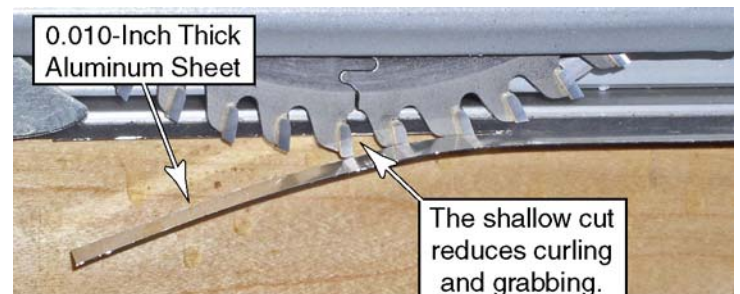

Extruded Aluminum





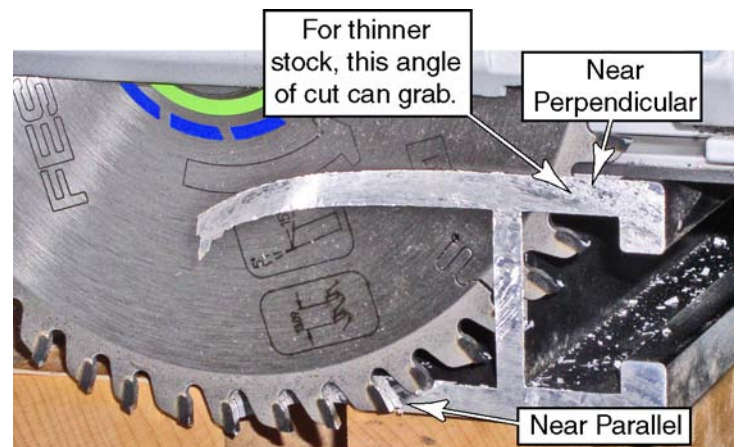

Care needs to be taken when cutting extruded aluminum because the blade may cut more aggressively than expected on the various surfaces of the stock. This is most noticeable with thin-walled extrusions.

- ▶ With thin-walled extrusions, try to keep the blade teeth parallel to the walls (see image above).
- ▶ With thick-walled extrusions, try to keep the blade teeth perpendicular to the walls (see image to the right).
- ▶ Use the negative hook angle, aluminum-cutting blade, and a moderate speed setting.
- ▶ Be prepared for the blade to catch unexpectedly as the cutting angle changes with each facet of the extruded shape.



Accessories

Sawblades

			
Description	Coarse Crosscut	Ripping (Panther)	Combination
Purpose	With a low tooth count and a high hook angle, this blade easily cuts through general construction materials.	The high hook angle of the Panther blade makes for effortless ripping without burning the cut.	With a moderate tooth count and hook angle, this blade provides good results when a single blade is needed for crosscutting and ripping.
Tooth Type	ATB, 12 teeth	ATB, 14 teeth	ATB, 28 teeth
Hook Angle	20°	37°	15°
Item Number	487 377	439 685	490 516
			
Description	Fine Crosscut	Fine Laminate	Aluminum and Plastic
Purpose	With a high tooth count, this blade provides excellent, chip-free crosscutting of lumber and fine (cabinet-grade) plywood.	The ultra-hard TCG teeth on this blade provide chip-free cutting of laminates and solid surface materials without dulling.	The negative hook angle and high TCG tooth count of this blade provides grab-free control for cutting aluminum and hard plastic.
Tooth Type	ATB, 48 teeth	TCG, 48 teeth	TCG, 56 teeth
Hook Angle	12°	4°	-5°
Item Number	491 952	489 457	439 686

Notes

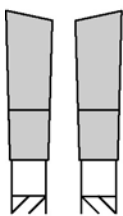

ATB

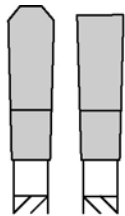

TCG

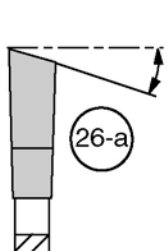

ATB: Alternate Top Bevel. The ATB type blade slices through wood fibers, first on one side and then on the other for clean cuts in natural and manmade materials.

TCG: Triple Chip Grind. The TCG type blade is designed to cut through hard materials. The trapezoidal tooth cuts the center of the kerf and the flat raker tooth cuts the edges. This type of blade design is more resistant to dulling.

26-a Bevel Angle: All of the ATB-type blades shown above have a bevel angle of 15°. This moderate bevel angle provides good chip-free cutting without rapidly dulling.

26-b Hook Angle: The higher the hook angle, the more the tooth grabs the material and pulls it into the cut. Ripping blades have a very high hook angle to cut aggressively. Lower hook angles are used for harder materials where greater control is needed.

Tooth Count: The more teeth a blade has, the smoother it will cut. Conversely, blades with fewer teeth cut more aggressively.

Guide Rails

Additional guide rails are available in lengths from 32 inches to 197 inches.



Dust Cover

Item Number: 491 750

The dust cover is for improved dust collection by covering the openings in the side of the blade cover.



Guide Rail Accessory Kit

Item Number: 492 396

Contains: Miter Gauge, Splinter Guard, Guide Stop, Cord Guide, Guide Rail Connection Bars, Guide Rail Clamps, Systainer.



Rip Fence (Parallel Guide)

Item Number: 491 469

Use the rip fence instead of the guide rail for making a rip using the edge of the workpiece as a reference.



Systainer (System Container)

Every Festool product is shipped in its own unique system container, called a "Systainer." This provides protection and storage for the tool and accessories. All Systainers are stackable and can be interlocked together, including stacking and locking atop Festool dust extractors.



Parts of the Systainer

- ▶ **Carrying Handle.** The carrying handle folds flat when not in use.
- ▶ **Cover Latches.** The two green latches on the front of the Systainer secure the cover. (These are also used for stacking Systainers, as described below.)
- ▶ **Stacking Latches.** The two gray latches on the sides of the Systainer are used for stacking one or more systainers together.
- ▶ **Stacking Tabs.** The stacking tabs are used to lock two systainers together. There are four sets of tabs (two on the front and two on the sides) of each systainer.

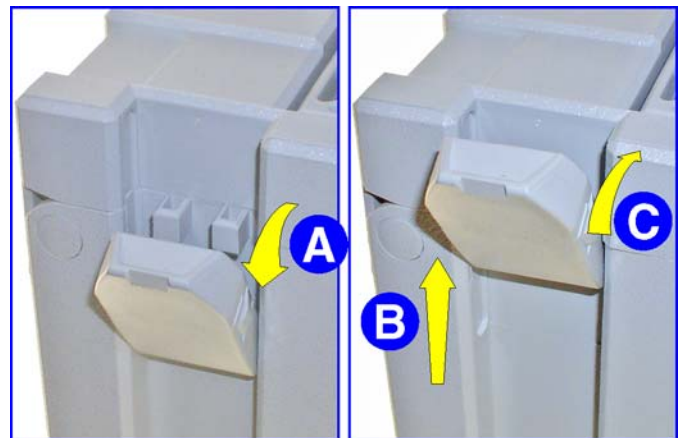

Stacking Systainers

For convenience in transporting Festool tools and accessories, the systainers can be stacked and locked together. The systainers are locked together using the stacking tabs and latches.

1. Place one systainer on top of the other.
2. Release all four latches on the lower systainer by pulling back at their top edges (step A to the right).
3. Slide all four latches upward (step B) as depicted by the two views.
4. Snap all four latches back to their flat position (step C) so they engage the stacking tabs of the upper systainer.

The image to the right shows two accessory systainers stacked together.



Troubleshooting

Symptom	Possible Causes
Motor does not start	<ol style="list-style-type: none"> 1. Check that the cord is properly plugged into an outlet. 2. Make sure the outlet has power. Check the circuit breaker or try another outlet. 3. If used with a Festool dust extractor, make sure the selector switch is pointing to "Auto". The auxiliary outlet on the dust extractor has power only when the selector is at Auto. 4. Inspect the power cord (including extension cords) for damage or missing prongs. 5. The motor brushes may have worn and need replacement.
The guide rail gib cams won't stay tight	<ul style="list-style-type: none"> ▶ The cams may be worn and have a flat-spot. Replace the cams. ▶ The friction washers may be worn or missing.
The saw makes a "Growling" sound when it is first turned on or idling.	<p>This sound is normal and expected. It is the result of the gears in the saw's heavy duty drivetrain reacting to the speed control of the motor.</p> <p>The electronic controller in the motor controls the motor speed by turning it On and Off very rapidly. This form of speed control is called "Pulse-Width Modulation" (PWM), and is common in most power tools with a variable speed control. When there is no load on the sawblade, the pulsations of the motor cause the gears to rapidly engage and disengage (called backlash), and this is the sound you are hearing.</p>
The saw makes wavy cuts	<ul style="list-style-type: none"> ▶ Make sure the guide rail gib cams are properly adjusted. ▶ Inspect the blade for damage. ▶ Make sure the sole plate is not rocking on the guide rail. ▶ Keep the blade depth consistent during the cut; don't raise and lower the blade. ▶ Forcing an ATB-type blade into the cut too fast can cause the blade to deflect.
Saw cuts are burning	<ul style="list-style-type: none"> ▶ Make sure to use the correct blade for the material. ▶ Make sure the blade is sharp. ▶ Make sure the blade is installed correctly (not turning backward). ▶ Reduce the motor speed. ▶ If possible, increase the blade depth.
Excessive chipping on the lower edge of the cut	<ul style="list-style-type: none"> ▶ Make sure to use the correct blade for the type of material and type of cut. ▶ A very shallow blade depth can cause chipping on the underside if the teeth are barely protruding below the surface. Increase the blade depth.
Excessive chipping on the top edge of the cut	<ul style="list-style-type: none"> ▶ Make sure to use the correct blade for the type of material and type of cut. ▶ Inspect the splinter guard. Make sure it is flush with the cut line for its entire length. ▶ Materials prone to splintering may splinter more if the blade is set too deep.

Maintenance

Routine Maintenance

Any maintenance or repair work that requires opening of the motor or gear housing should be carried out only by an authorized Customer Service Center (name supplied by your dealer)! Maintenance or repair work carried out by an unauthorized person can lead to improper connection of electrical wires or other components, which can result in injury.

To prevent injury or electrocution, always unplug the tool from the power supply outlet before performing any maintenance or repair work on the tool!

Do not use compressed air to clean the motor housing of the tool, as you could inject foreign objects into the motor through the ventilation openings. Compressed air may be used on other components, but personal safety protection should be employed (hearing, vision, and respiratory).

Certain cleaning agents and solvents are harmful to plastic parts. Some of these include, but are not limited to: Gasoline, Acetone, Methyl Ethyl Ketone (MEK), Carbonyl Chloride, cleaning solutions containing Chlorine, Ammonia, and household cleaners containing Ammonia.

To ensure proper cooling of the tool and motor, the cooling vents in the motor housing must always be kept clear and clean.

Keep the Saw Clean

Dust and debris from some materials can be extremely abrasive and cause components within the saw to wear prematurely. It is important to keep moving parts cleared of abrasive dusts.

- ▶ As a general rule, keep the saw clean of all dust and debris. Even soft-wood dust can be abrasive over time.
- ▶ Examine all moving parts for dust and debris.

- ▶ Keep the bevel hinges clean of dust using compressed air or cotton swabs. If the hinges wear due to abrasive particles, the saw will not perform optimally.
- ▶ Keep the blade area and dust extraction port clean of debris. Debris can cause wear and reduce the effectiveness of the dust extraction system.

Keep the Sawblades Sharp

Using a dull sawblade can be extremely dangerous and provide poor cut quality.

- ▶ Never attempt to sharpen a sawblade manually. Special equipment is necessary to properly sharpen a circular sawblade. An improperly sharpened sawblade can injure the operator, destroy the saw, and damage the workpiece.
- ▶ The sawblades should be sharpened regularly, and only by a qualified sharpening service.
- ▶ Improper grinding of the carbide teeth of a sawblade can result in serious injury to the saw operator.

Adjust and Inspect the Saw

To ensure the saw is in proper working order, periodically inspect the operation of the saw and ensure it is properly adjusted.

- ▶ Observe the function of the saw during normal operation.
- ▶ Unusual sounds are indicative of pending problems.
- ▶ A reduction in the cut quality indicates the saw is either improperly adjusted or not functioning properly.
- ▶ A reduction in cutting power or speed may indicate a dull blade or a motor problem.
- ▶ If any of the safety devices on the saw are inoperable or disabled, immediately stop using the saw and have it serviced.
- ▶ Periodically inspect the guide rail gibs cams for wear and proper adjustment. If the cams are worn or misadjusted, the saw will not cut straight.

Replacing the Guide Rail Gib Cams

If the gib cams are over tightened, or the saw is used in an environment with abrasive dust, the cams may develop flat spots and should be replaced. Maintaining proper adjustment and keeping the saw clean will increase the life of the cams.

- ▶ Unplug the saw for safety, and lay the saw on its side on a stable work surface.
- ▶ Using a T-15 Torx® driver, remove the screw that secures each cam to the sole plate, and remove the cam and friction washer.
- ▶ The replacement parts kit will include 2-cams, 2-friction washers, and 2-screws.
- ▶ Install the new cams and friction washers with the screws provided.
- ▶ Make sure the limit tabs are pointing away from the guide rail slot as shown.
- ▶ Tighten the screws enough to compress the friction washers, but take care not to over tighten the screws.

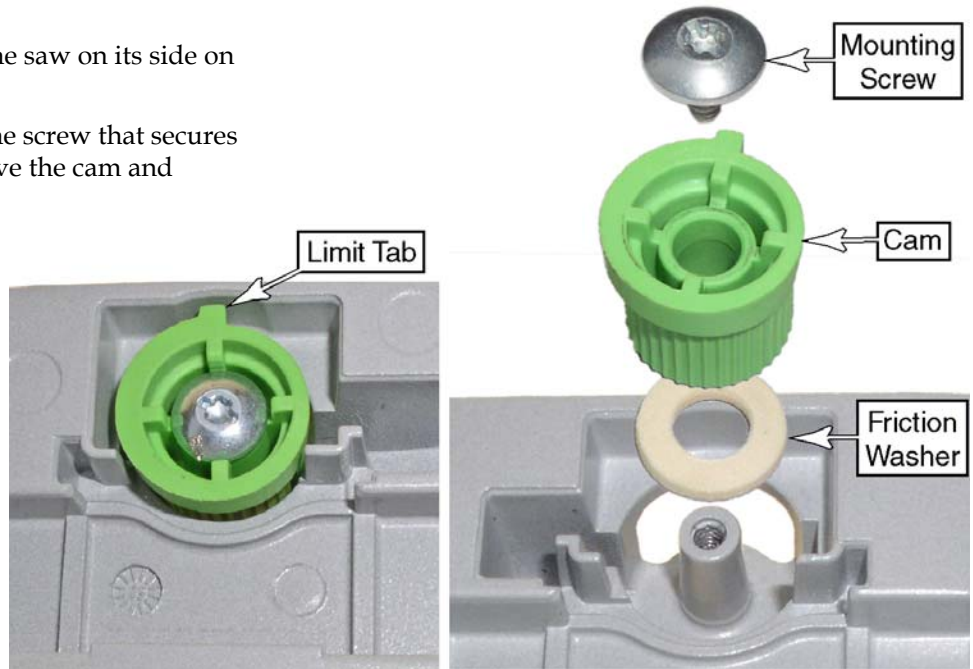

- ▶ Adjust the cams according to the procedure on page 8.

Replacing the Guide Rail Splinter Guard

The splinter guard prevents splintering and chipping of the workpiece by holding the top edge of the workpiece down as the teeth of the sawblade move upward against it. The splinter guard needs to be replaced if it becomes damaged or worn.

1. Peel the original splinter guard away from the guide rail.
2. As needed, clean residual adhesive and debris from the guide rail.
3. Peel off the plastic backing from the new splinter guard to expose the adhesive.
4. Without stretching the rubber, carefully place the new splinter guard on the underside of the guide rail tight to the alignment rib (14-b).
5. Make sure the splinter guard is firmly pressed down to the guide rail.

6. Trim the splinter guard as described on page 8.

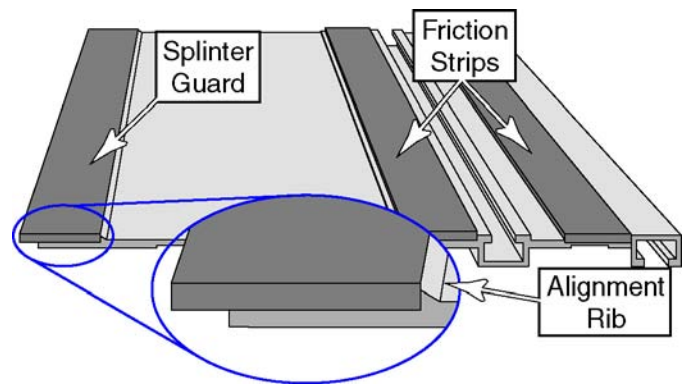

Changing the Motor Brushes

The motor brushes wear out over time and need to be replaced by an authorized service center. Festool does not condone brush replacement by the end-user. Completion of this procedure by an unauthorized service center will void the tool's warranty.

The motor brushes are graphite bars that provide an electrical connection between the motor controller and the rotating armature. When the brushes have worn past their useful length, spring loaded wear pins are exposed that separate the brush from the armature contacts. This disables the motor to prevent damage. For a shorter break-in period without excessive arcing, new brushes have ribs that quickly form to the curve of the armature.

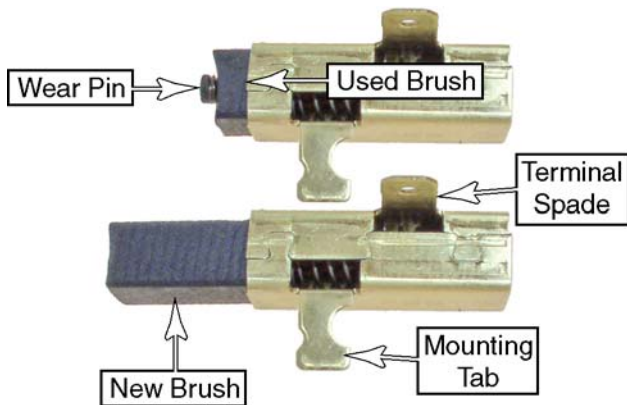

Procedure



CAUTION! Make sure the power cord is unplugged before beginning this procedure.

1. Remove the four screws that secure the access cover to the motor, and remove the cover.

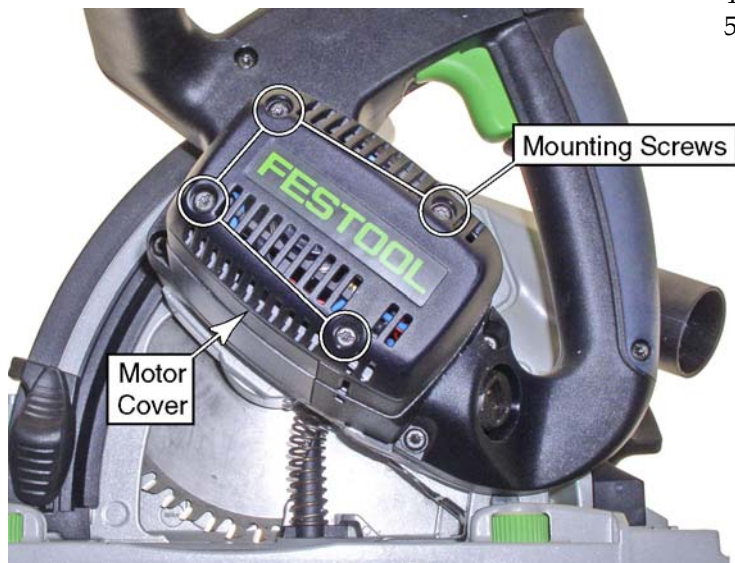

2. Lift the wire connectors off the terminals on the brushes.
3. Remove the screw that secures each brush to the motor housing. Be careful not to drop the screws into the motor.
4. Carefully lift the brushes up to remove them.
5. Insert the new brushes into the motor, and reassemble the saw by reversing the previous steps.

